

LGB documents provided courtesy of:

TRAINLI

You can find everything you need for your hobby at

[Click Here >>>](#) www.trainli.com

+1 (775) 302-8111

[like us on Facebook](#)

<https://www.facebook.com/trainlipage/>



SERVICE

Weitere Informationen
erhalten Sie von Ihrem autorisierten LGB-Händler und bei
Ernst Paul Lehmann Patentwerk
Saganer Strasse 1-5
D-90475 Nürnberg
DEUTSCHLAND
Tel.: (0911) 83707 0
Fax: (0911) 83707 70
www.lgb.de

Achtung! Geben Sie bei der Bestellung eines Ersatzteils bitte die Nummer der Zeichnung oben auf dieser Seite (z. B. "2019S-1") und die Nummer des Teils auf der Zeichnung (z. B. "15") an.

Achtung! Produkte und technische Daten können sich ohne Vorankündigung ändern.

LGB, LGB of America, LEHMANN und der LGB TOYTRAIN-Schriftzug sind eingetragene Marken der Firma Ernst Paul Lehmann Patentwerk, Nürnberg, Deutschland. Andere Marken sind ebenfalls geschützt. © 2003 Ernst Paul Lehmann Patentwerk.

For more information,
contact your authorized LGB retailer or:

<i>in North America</i>	<i>in all other areas</i>
LGB of America	Ernst Paul Lehmann Patentwerk
6444 Nancy Ridge Drive	Saganer Strasse 1-5
San Diego, CA 92121	D-90475 Nürnberg
Telephone: (858) 795-0700	Telephone: (0911) 83707 0
Fax: (858) 795-0780	Fax: (0911) 83707 70
USA	GERMANY
www.lgb.com	www.lgb.de

Attention! When ordering a part, please include the drawing number at the top of this page (e.g., "2019S-1") and the number of the part in the drawing (e.g., "15").

Attention! Products and specifications are subject to change without notice.

LGB, LGB of America, LEHMANN and the LGB TOYTRAIN logo-type are registered trademarks of Ernst Paul Lehmann Patentwerk, Germany. Other trademarks are the property of their owners. © 2003 Ernst Paul Lehmann Patentwerk.

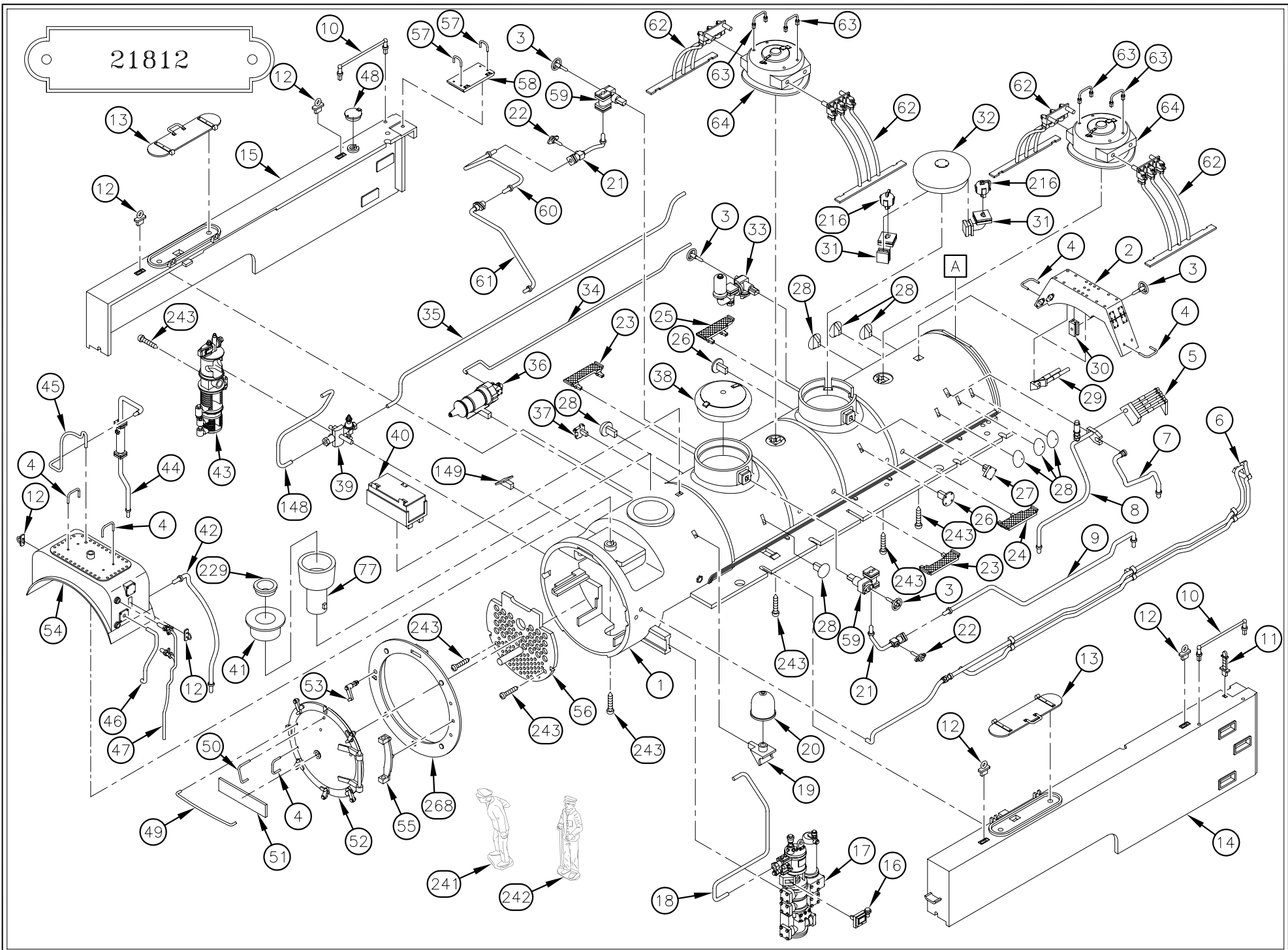

21812

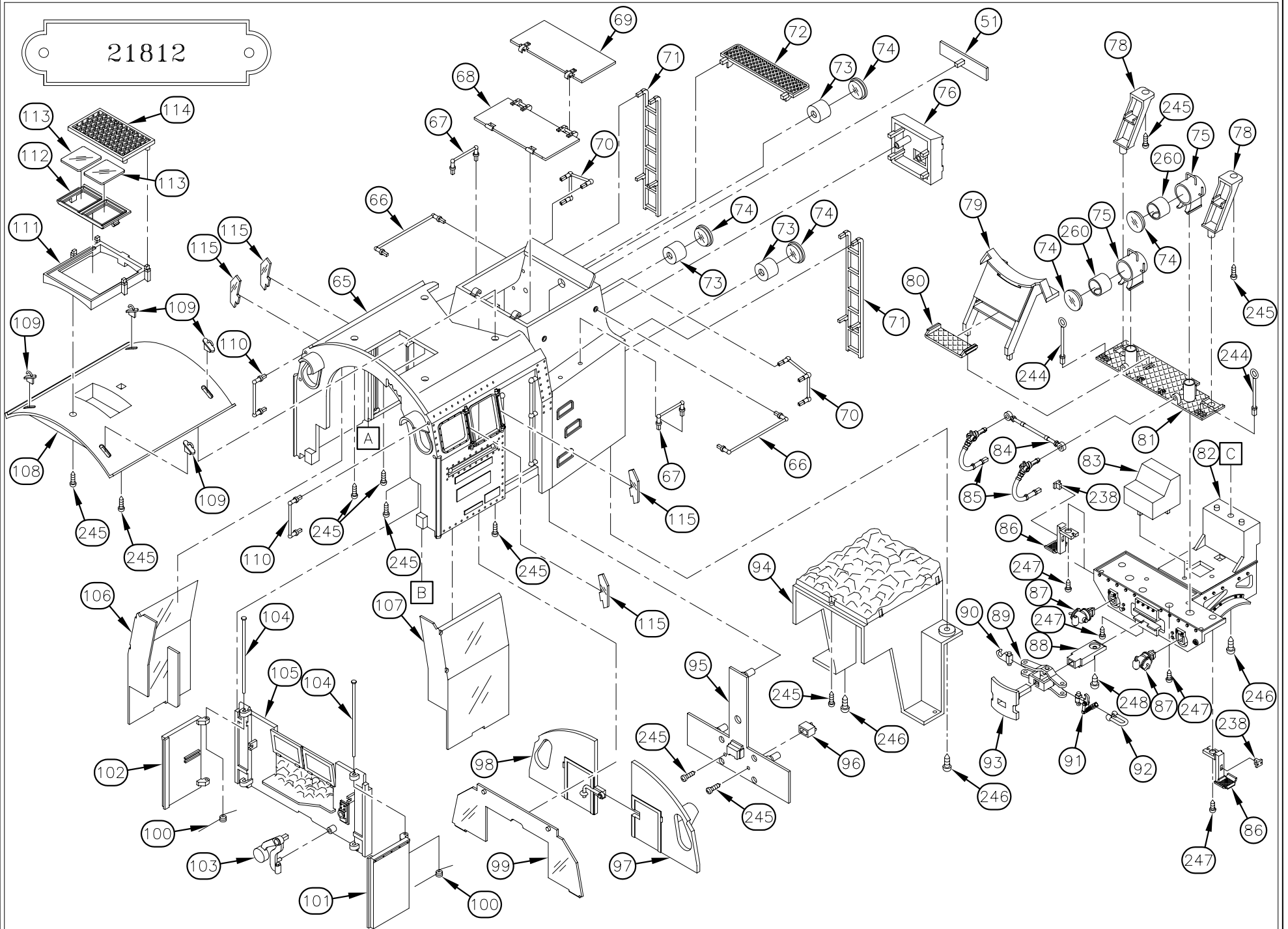

21812

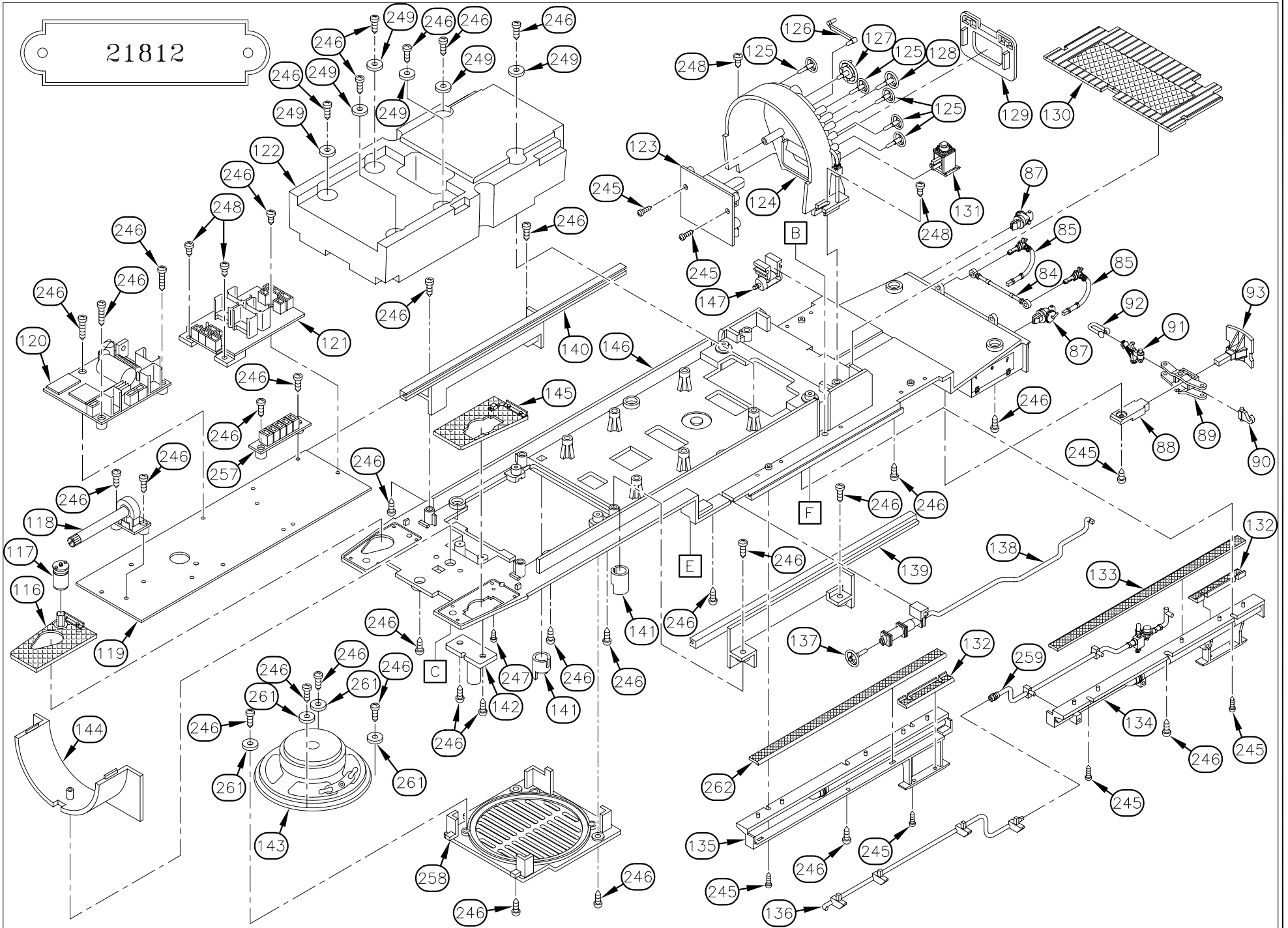

21812

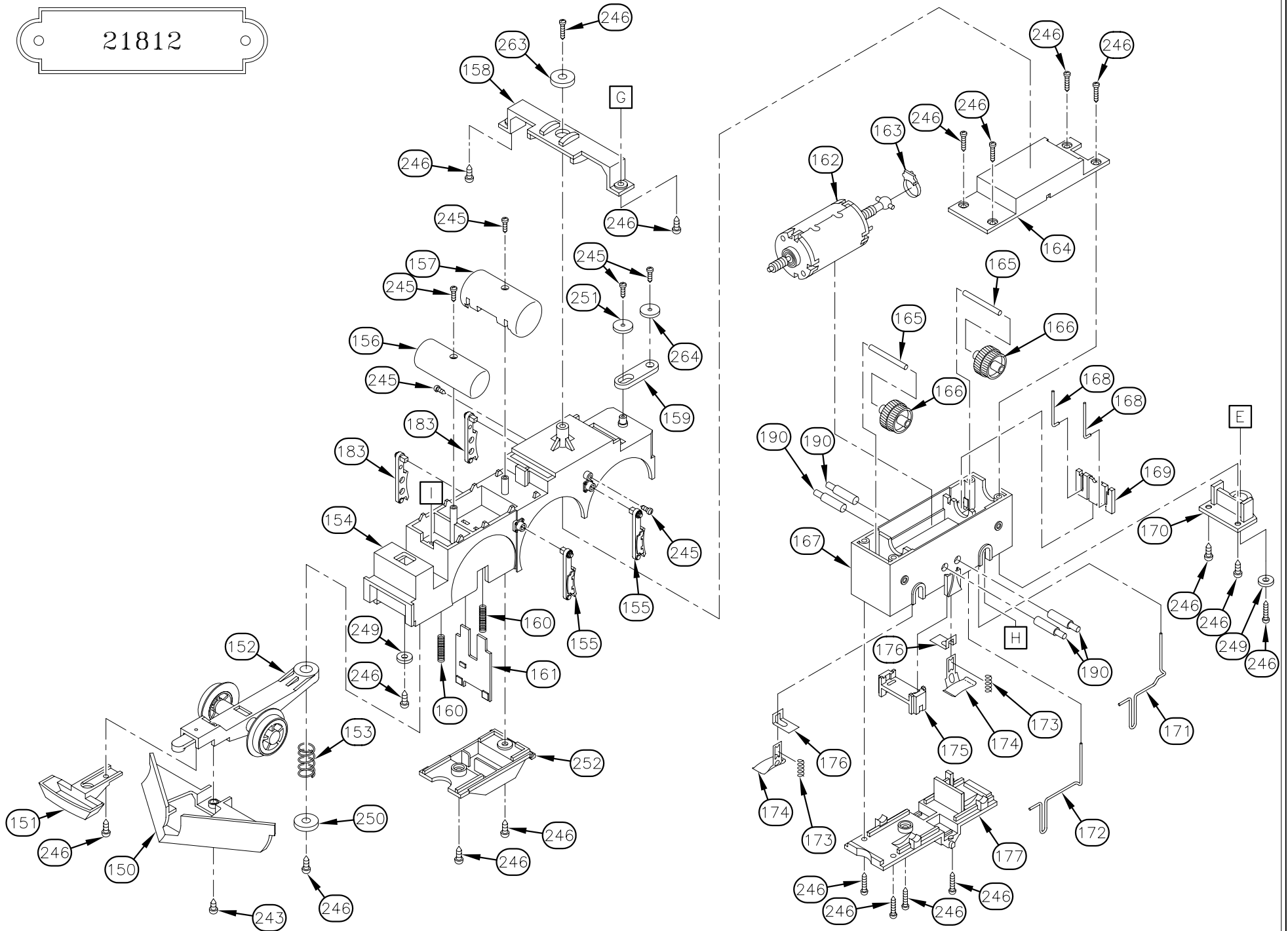

21812

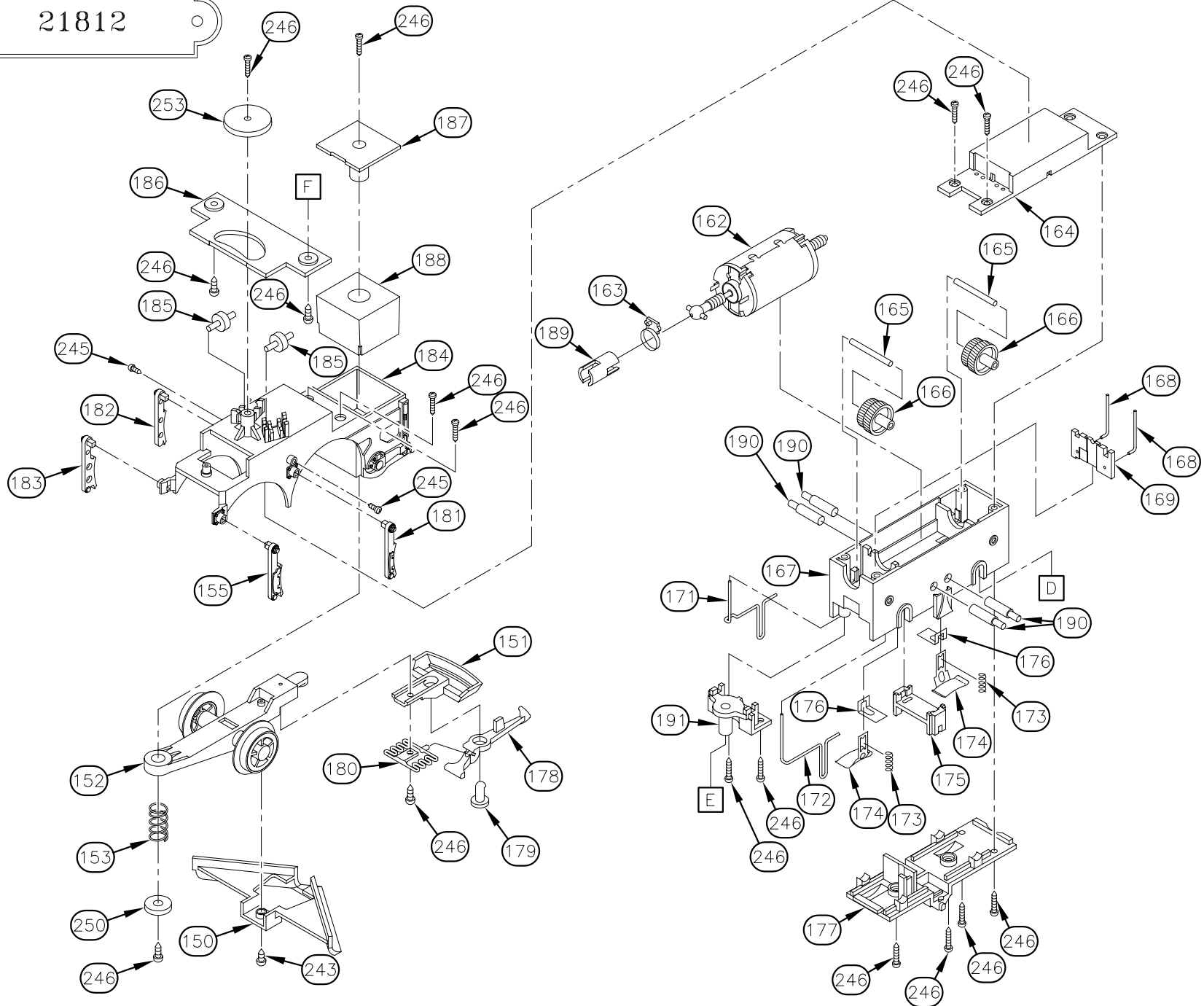

21812

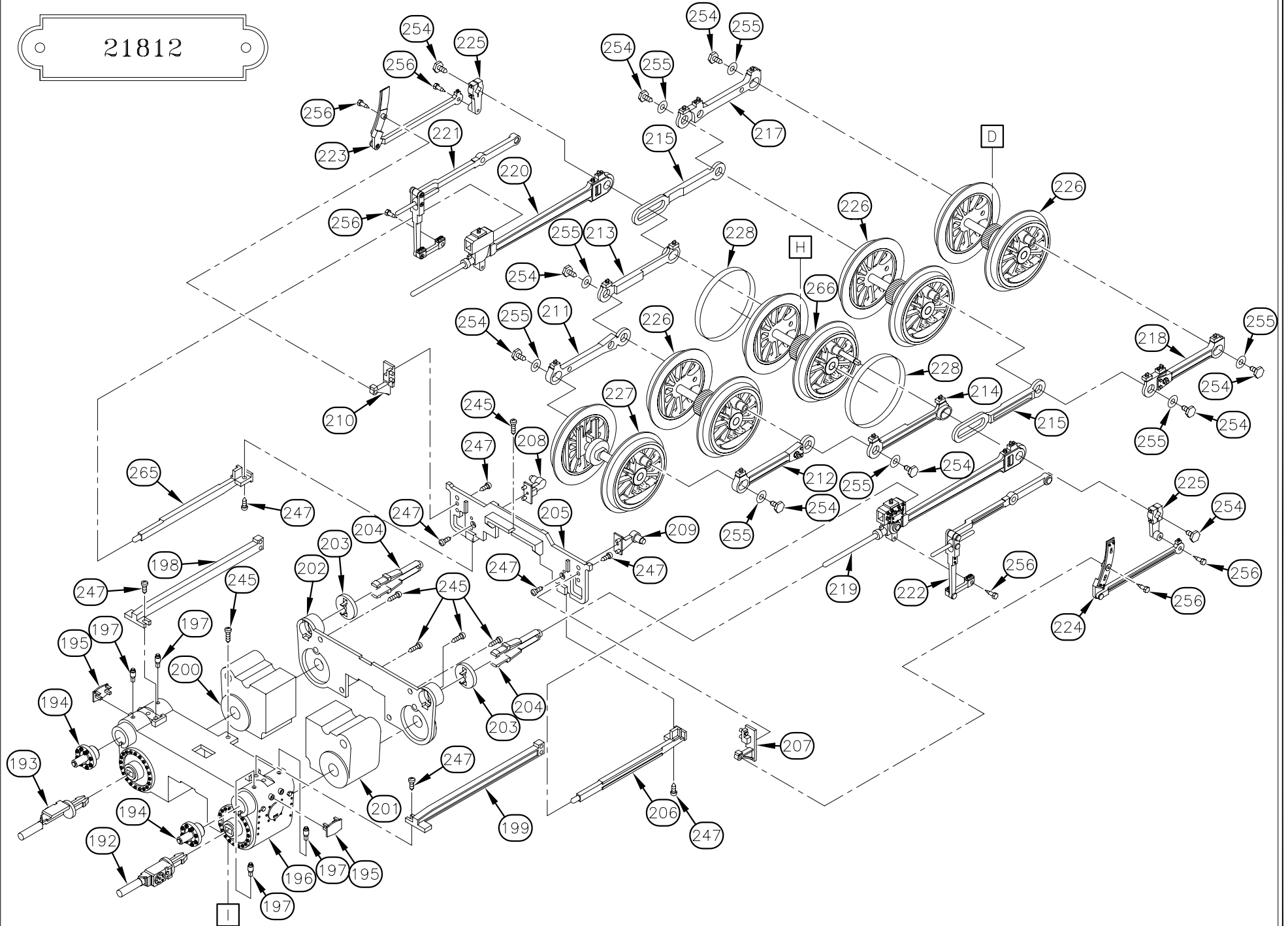

21812

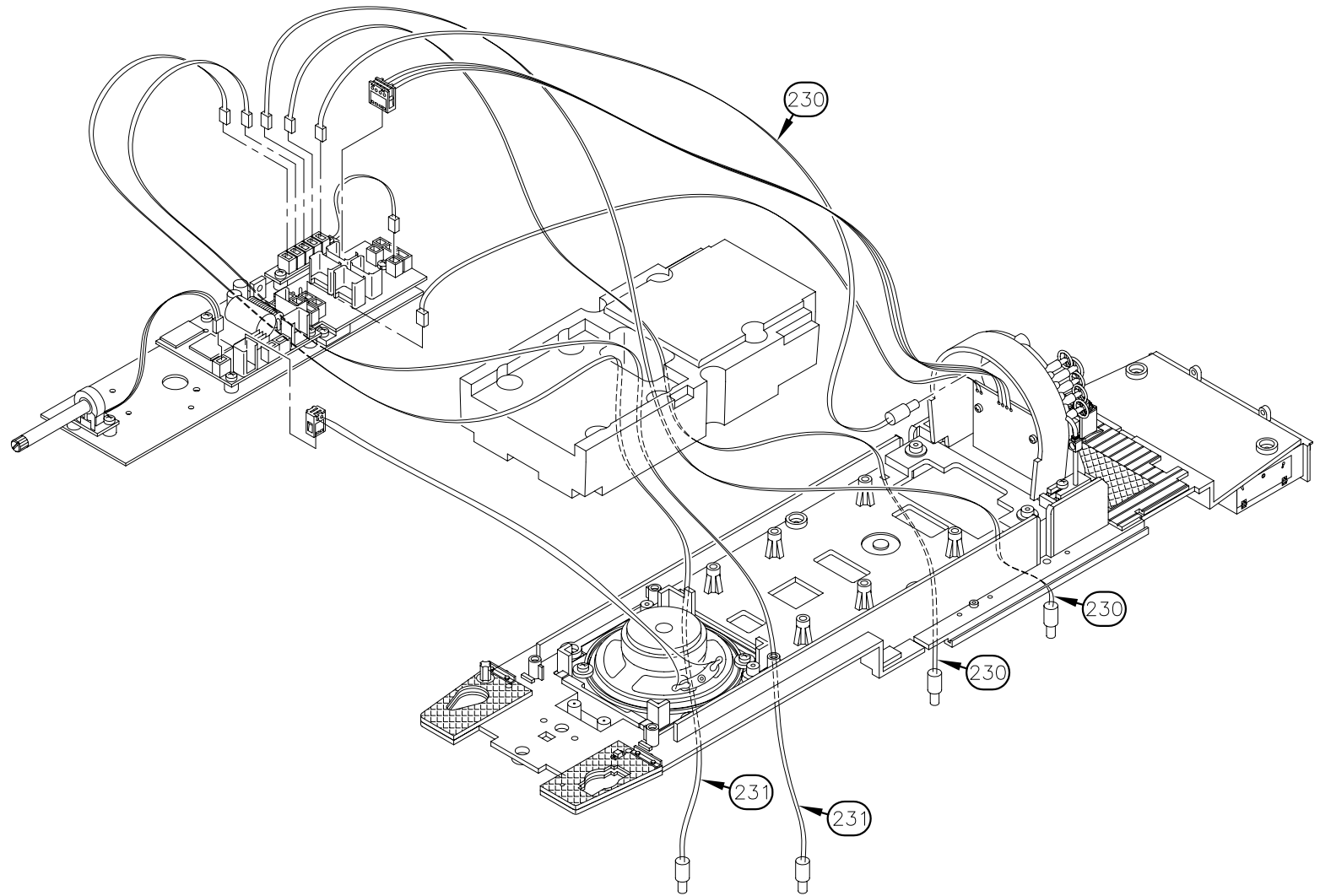

21812

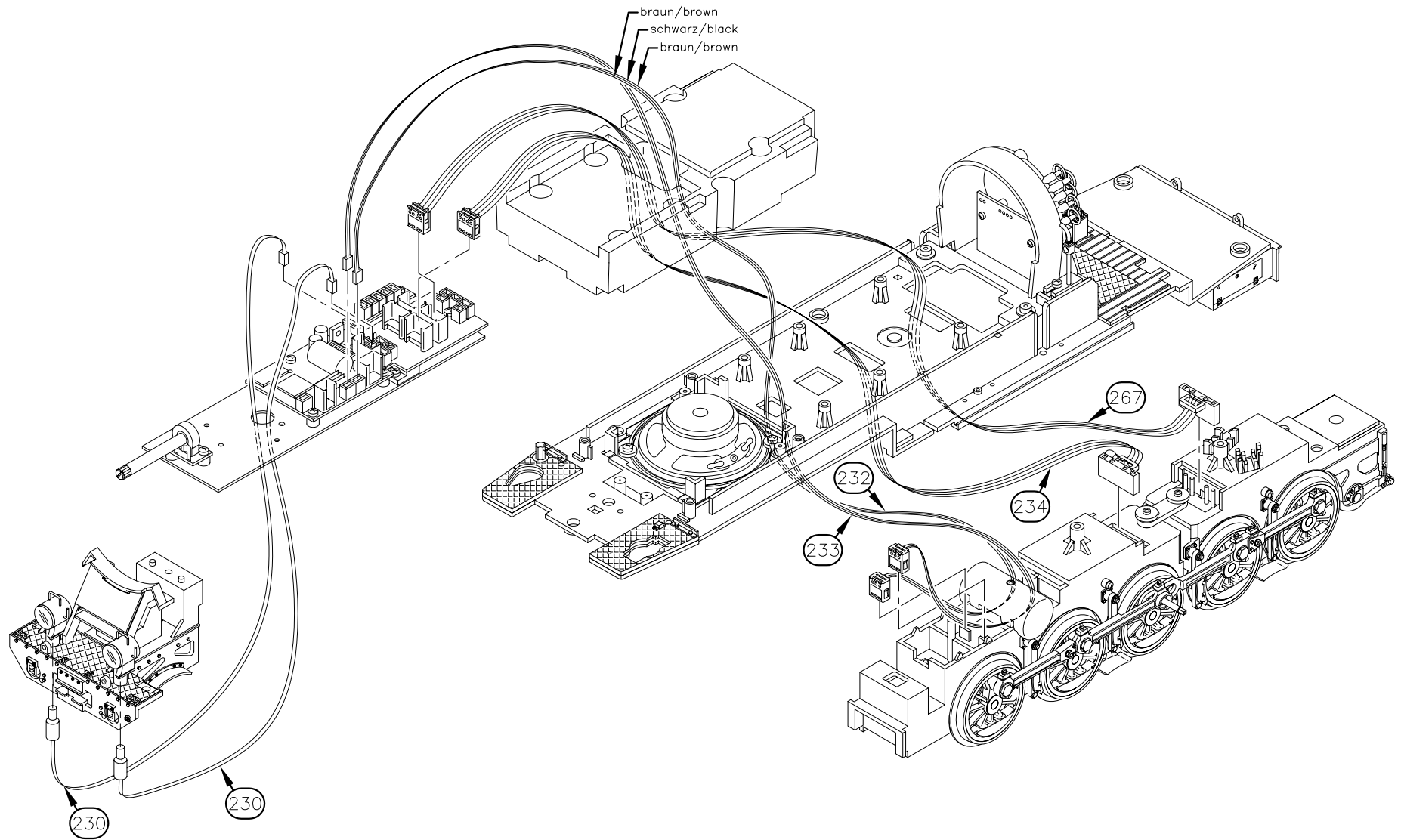

21812

